

標準図

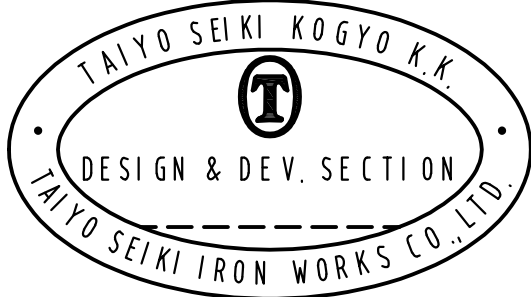
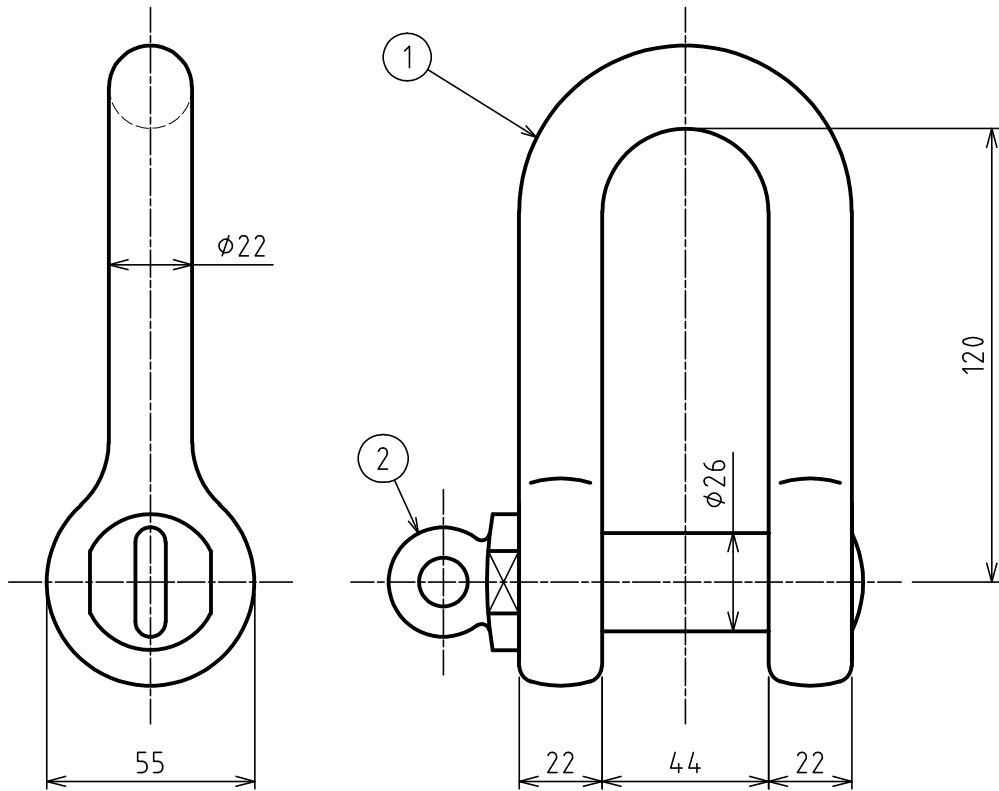

基本使用荷重 WLL	5 ton (50kN)
計算質量 WEIGHT	△ 1.8 kg
表面処理 FINISH	オレンジ塗装 ORANGE PAINTED

2	ピン PIN		1		
1	本体 BODY		1		
符品 ITEM	部品名 NAME OF PART	材料 MATERIAL	個数 NO. REQ'D	計算質量 (kg) WEIGHT CALCULATED	摘要 REMARKS

来歴 CAREER  
 △質量変更  
 2024.2.26 K.T

名称 NAME	軽量シャックル KEIKLE SHACKLES					RSS-5 t
作成日 DATE	尺度 SCALE	承認 APPROVED	照査 CHECKED	設計 DESIGNED	作図 DRAWN	
2020.6.24	1:2	S.Oshitamoto	S.Oshitamoto	-	M.Ando	
大洋製器工業株式会社 TAIYO SEIKI IRON WORKS CO., LTD.					図番 DWG. NO.	C12-3001