

標準図

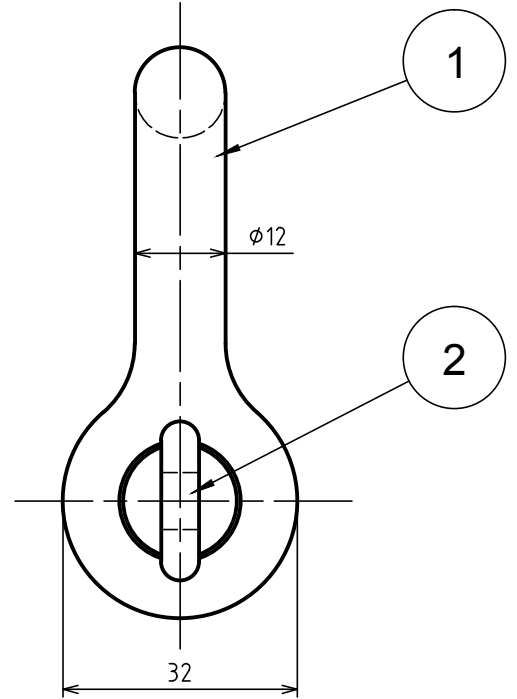
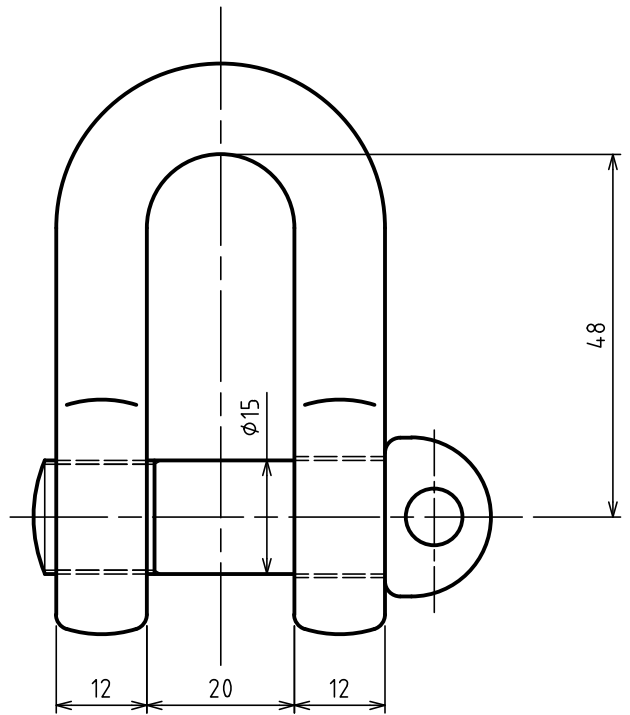

基本使用荷重 WLL 1 Ton (10kN)

計算重量 WEIGHT 0.24 kg

JIS B 2801 (1996) に準ずる。
BASED ON JIS-B-2801 (1996)

等級 GRADE M 級 M

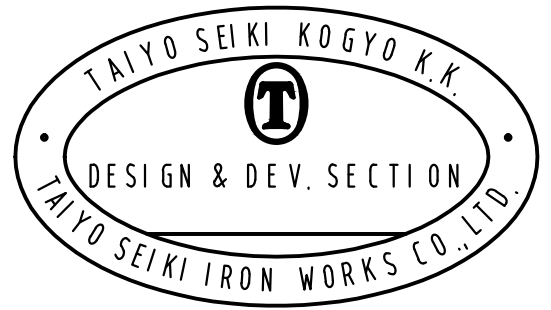

2	ピン	PIN		1		
1	本体	BODY		1		
符品 ITEM	部品名 NAME OF PART	材料 MATERIAL	個数 NO. REQ'D	計算重量 [kg] WEIGHT CALCULATED	摘要 REMARKS	

来歴 CAREER	名称 NAME	JIS形シャックル JIS TYPE SHACKLES				SC-12
	作成 DRN DATE	尺度 SCALE	部長 DIRECTOR	課長 MANAGER	検図 CHD BY	製図 DRN BY
	2009.Sep.18	Free		N.Fuji	Do	Y.SAKAMOTO
	大洋製器工業株式会社 TAIYO SEIKI IRON WORKS CO., LTD.				図番 DWG. NO.	C43-3004